



**Cal/OSHA, DOT HAZMAT, EEOC,
EPA, HAZWOPER, HIPAA, IATA,
IMDG, TDG, MSHA, OSHA, and
Canada OHS Regulations and
Safety Online Training**

Since 2008

This document is provided as a training aid
and may not reflect current laws and regulations.

Be sure and consult with the appropriate governing agencies
or publication providers listed in the "Resources" section of our website.

www.ComplianceTrainingOnline.com



[Facebook](#)



[LinkedIn](#)



[Twitter](#)



[Website](#)

FALL PROTECTION FOR THE CONSTRUCTION INDUSTRY

SUMMARY PACKET

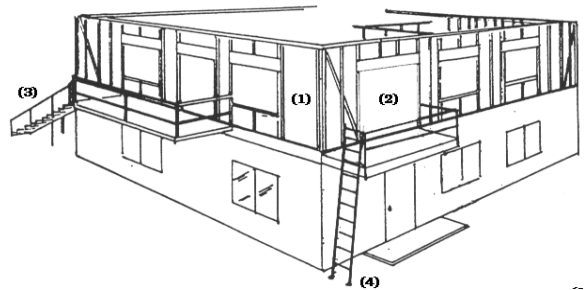
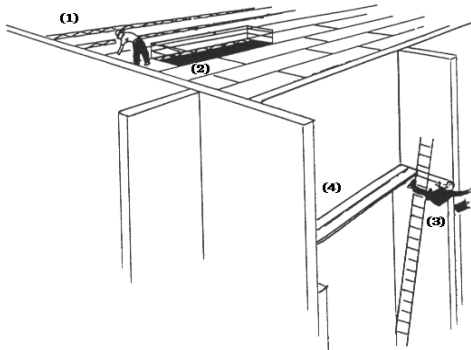
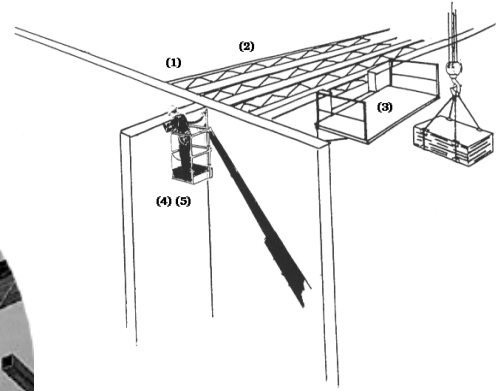
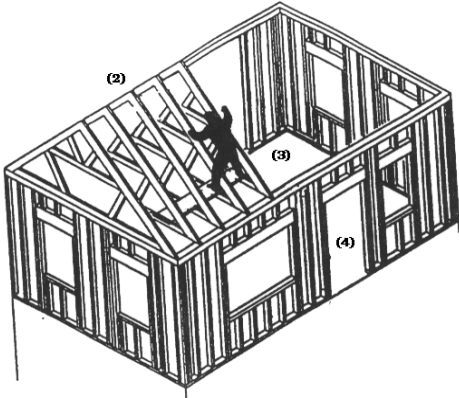

DEPARTMENT OF INDUSTRIAL RELATIONS



EDUCATION AND TRAINING

NOVEMBER 2001

This summary packet is designed to help explain the 1997 changes in California's Fall Protection Standards. It is not meant to be either a substitute for, or a legal interpretation of, the occupational safety and health standards. The reader is cautioned to refer directly to California Code of Regulations Title 8.

The Cal/OSHA Standards Board adopted new fall protection requirements for the construction industry, effective August 27, 1997. The new standard is more in line with the Fed/OSHA fall protection standard in 29 CFR 1926, Subpart M. It establishes criteria for equipment design, strength, and quality testing; pre-use inspection; labeling; fall systems maintenance; and employee training. It covers requirements for fall arresting equipment including full body harnesses, lifelines, rope grabs, anchorage points and connectors. As of January 1, 1998, the standard prohibits body belts and nonlocking snap hooks for fall arrest, allowing body belts only for positioning device systems or fall restraint (1670). The standard requires personal fall arrest systems be inspected prior to each use for wear, damage, and defects(1670-b-16) and inspected by a competent person at least twice a year, in accordance with the manufacturer's recommendations, with inspection dates documented.*

The revised standard maintains the trigger heights of: 7-1/2 feet (anyone working on platforms, scaffold, etc.); 15 feet (iron workers, panelized roof constructors, and employees working on 4" or wider structural members); 20 feet (roofers); 30 feet (iron workers-connecting steel); and 6 feet (rod busters working on vertical rebar). Terms such as "safety belts and lanyards" have been replaced with references to "personal fall arrest, personal fall restraint, or positioning systems" or "personal fall protection system" (1670). The new standard provides for the use of safety nets "where the elevation is 25 feet or more...and when the use of personal fall arrest systems, personal fall restraint systems, positioning device systems or more conventional types of protection are clearly impractical" (1671).

Employers are required to provide training for any employee who might be exposed to a fall hazard prior to the exposure or upon hiring (CCR 1509). Training must include an explanation of the company's fall protection policies and safe work practices with general instructions and precautions, specific instructions where required, hazard identification and correction; selection and proper use of protective devices, and maintenance of equipment. Instruction should also include correct procedures for inspecting, erecting, disassembling, and maintaining fall protection systems used; and the employee's role in fall safety monitoring. Basic and essential elements should be clearly described and understood by all participants.

Where a fall hazard exists, employers must eliminate the hazard, provide protection against the hazard, or implement a fall protection plan in accordance with Sections 1671.1 and 1671.2.

*Competent person: An individual knowledgeable of a manufacturer's recommendations, instructions and manufactured components who is capable of identifying existing and predictable hazards in the proper selection, use and maintenance of fall protection.

FALL PROTECTION TRIGGER HEIGHTS



Above 30' - *Iron workers: Connecting steel only*



Above 20' - *Roofers*



Above 15' - *Iron Workers, panelized roof construction (Section 1716.1), and employees on 4 inch nominal or wider structural members.*



Above 7½' - *Anyone working on unprotected platforms, scaffolds, or edge of structures.*



Above 6' - *Rod busters: Working with rebar (exception is point to point travel)*



Grade or Ground - *Not required*

TABLE OF CONTENTS

I. Cal/OSHA Fall Protection Summary Sheets

STANDARDS

A	Guardrails and Covers	1
B	Personal Fall Protection	2
C	Roofing Operations	2
D	Access and Housekeeping	3
E	Prohibited Types of Scaffolds	3
F	Safety Nets	3

SPECIFICATIONS

A	Guardrails	4
B	Perimeter Cable	4
C	Toeboard	4
D	Covers	4
E	Body Belts or Harnesses	4
F	Roof Warning-lines	4
G	Safety Nets	4
H	Fall Protection Plan	5
I	Controlled Access Zones & Safety Monitoring Systems	5

	Consultation Offices (Toll-Free Number)	6
--	--	----------

II. Cal/OSHA Fall Protection Blueprints

Residential Construction

- Framing Walls and Multi Activities
- Rafter/Truss/Joist Installation
- Decking/Sheathing
- Roofing

Commercial Construction

- Decking
- Pre Cast, Wood, Metal
- Structural Steel
- Roofing

CAL/OSHA FALL PROTECTION SUMMARY SHEETS

STANDARDS

A. **Guardrails and Covers**

When and where needed?

1. *Guardrails are needed wherever the workers could fall 7 1/2 feet or more from scaffolds, runways, ramps, elevated platforms and surfaces. [1621(a)] Exceptions:*
 - (1) *Float and ladder jack scaffolds.*
 - (2) *Bricklayers' and masons' scaffolds used in accordance with Sections 1641(e) and 1644 (a)(6).*
 - (3) *During demolition on the floor or surface being demolished.*
2. *All stairs and stairwells need railings, toe boards and handrails. [1626(a)] and 1626(b)]*
3. *All floor, roof and skylight openings shall be guarded by railing and toeboards or be covered securely. The cover capable to support greater than a 200—pound person or the weight of worker(s) and material(s) placed thereon. Covering shall prevent accidental removal or displacement and bear one inch painted or stenciled sign, stating: "Opening—Do Not Remove." Markings of chalk or keel shall not be used. [1632(b)]*
4. *Ladderway floor openings or platforms need railings. [1632(c)]*
5. *Pits and trap—door floor openings need railings or covers. [1632(e)]*
6. *Manhole floor openings shall be guarded by covers or shall be protected by standard railings. [1632(f)]*
7. *Temporary floor openings shall have standard railings. [1632(g)]*
8. *Floor holes, into which persons can accidentally walk, shall have either a railing with toeboard on all exposed sides or a cover secured against accidental displacement. [1632(h)]*
9. *Wall openings with a drop of more than 4 feet and the opening bottom is less than 3 feet above the working surface, shall be guarded as follows:*
 - (1) *When the height and placement of an opening in the working surface is such that either a standard or intermediate rail will effectively reduce the danger of falling, one or both shall be provided;*
 - (2) *The bottom of a wall opening, less than 4 inches above the working surface, regardless of width, shall be protected by standard toeboard or an enclosing screen of solid construction. [1632(j)]*
10. *Extension platforms outside a wall opening. One side may have removable railings in order to facilitate material handling. [1632(k)]*
11. *When a chute is attached to an opening, this section shall apply, except a toeboard is not required. [1632(i)]*
12. *Elevator shafts that do not have a cage or are not enclosed shall be guarded on all open sides. [1633(a)]*
13. *Excavation cross-overs need railings where the excavation is over 6 feet deep and over 30 inches wide. [1541(l)(1), (2)]*
14. *Dredge discharge pipelines used as walkways need at least a top rail. [1603(a)]*
15. *Catwalks and platforms need railings over water that is deeper than 4 feet. [1603(b)]*
16. *Exposed edges of all temporary planked or temporary metal decked floors at the periphery of skeleton steel structure more than 30 feet in height need railings. [1710(e)(3)]*
17. *Perimeter and openings need railing as soon as falsework is erected. [1717(d)(4)]*
18. *At demolition sites wall openings need railings — except the ground floor and the floor being demolished. [1735(k)]*

B. Personal Fall Arrest Systems, Personal Fall Restraint Systems and Positioning Devices

When and where needed?

Where guardrail or safety nets are not practical, workers must use approved personal fall arrest systems, personal fall restraint or positioning devices when:

1. Exposed to a falling distance greater than 7 1/2 feet from the perimeter of a structure or through shaftways and opening; Down sloped roof surfaces steeper than 7:12 or down other slopes steeper than 40 degrees. [1670(a)] Note: For employees working at elevated locations on poles, towers and other structures see Section 2940.6(b) and (c) of the High Voltage Electrical Safety Orders or Section 8615(g) of the Telecommunications Safety Orders.
2. Exposed to a falling distance greater than 15 feet from a truss, purlin, beam or top plate of 4 inch nominal width or similar locations. [1669(a)]
3. Removing the last panel when gathering and stacking temporary floor planks. [1635(b)(11)]
4. Using pneumatic nailers on roofs of 1/3 pitch or steeper. [1704(d)]
5. Working from:
 - Boatswain's chairs 1662(c)
 - Float scaffolds 1663(a)(5)
 - Needle beam scaffolds 1664(a)(12)
 - Suspended scaffolds 1660(g)
6. Connecting beams with fall distance greater than 30 feet [1710(g)(1)]
7. Other than connecting with fall distance of 15 feet or greater. [1710(g)(2)]
8. Workers engaged in installation and construction of structural wood framing system over 15 feet shall use guardrails, safety net or personal fall protection system or other methods in Article 24. Employees working at the leading edge shall be provided with either fall protection, utilize a fall protection plan or be protected by parapets at least 24 inches high. [1716.1(c)(1)]
9. Tight substantial floors to be installed every 2 stories or every 30 feet, whichever is less for steel structures. [1710(e)(4)] Note: Where a planked floor is not practical, safety nets shall be installed when the potential fall distance is more than 30 feet.
10. When gathering and stacking temporary floor planks from the last panel, the assigned workers are required to wear approved personal fall arrest with lines attached to a catenary line or other substantial anchorage. [1710(e)(4)(B)]

C. Roofing Operations

1. Fall hazards from falling off roofs must be prevented regardless of height. [1509, & 1510]
2. Worker on roofs of more than 20 feet in height requires the following fall protection devices:
 - For monolithic roof covering (e.g., built-up roofs) where the slope is 0:12 through 4:12. [1730(b)]
 - warning lines and headers shall be placed no closer than 5 feet from the roof edge, or
 - catch platforms with guardrails, or
 - scaffold platforms, or
 - eave barriers, or
 - standard railings and toeboards.
 - For monolithic roof coverings where the slope exceeds 4:12. [1730(c)]
 - parapets 24 inches or higher, or
 - approved personal fall arrest and lines, [1724(f)] or
 - catch platforms, [1724(c)] or
 - scaffold platforms, [1724(d)] or
 - eave barriers, [1724(e)] or
 - standard railings and toeboards. Article 16

Note: Provisions in 1730(c) do not apply when motorized equipment is used on which the operator rides. The equipment must be designed for use on roofs with slopes exceeding 4:12 with a parapet at least 36 inches high at roof edges which are perpendicular or nearly so to the direction in which the equipment is moving. [1730(c)]

For Multiple-Unit Roof Coverings (e.g., shingles or tiles) with a slope of 0:12 through 5:12. [1730(e)]

- roof jack system, or
- parapet at least 24 inches high, or
- other method that gives equivalent protection.

For Multiple-Unit Roof Coverings with slopes greater than 5:12. [1730(f)]

- parapet at least 24 inches high, or
- approved personal fall arrest and lines, [1724(f)] or
- catch platforms, [1724(c)] or
- scaffold platforms, [1724(d)] or
- eave barriers, [1724(e)] or
- roof jack systems. [1724(a)] (Safety lines shall be required in conjunction with roof jack systems on roofs steeper than 7:12)

3. Equipment shall not be pulled backwards by an operator on a roof with a slope greater than 4:12. [1730(d)]
4. When pulling felt laying equipment, fall protection is required regardless of height. [1730(b)(1)]

D. Access and Housekeeping

1. Access requirements to get to and from all platforms and levels. [1629, 1630]
2. Keep walkways [1624], ladders [1629], [1675-1678], and/or stairs [1629] safe and clear at all times.
3. Assure all work areas are free of all tripping hazards. [1513]

E. Prohibited Types of Scaffolds

1. Lean-to or jack scaffolds, shore scaffolds, nailed bracket, loose tile, loose blocks, stilts, or other similar unstable objects shall not be used as working platforms, or for the support of such platforms. For examples see Section 1938 Plate B-40 Appendix.
Exception: Bricklayer's "jump boards" no higher than 20 inches above the regular scaffold platform are acceptable for such service when supported by piers of carefully piled bricks or concrete blocks. [1637(j)]

F. Safety Nets

Safety nets must be used when the following conditions exist:

1. Approved personal fall protection is required but its use is impractical. [1669(b)]
2. At the exterior and interior perimeter of the structure if the elevation is 25 feet or more and the use of approved personal fall protection is impractical. [1671(a)] **Exception:** See Section 1710 (d), (e) and (f) for flooring requirements and nets for steel erection in tiered buildings and structures.
3. The building structure is not adaptable to temporary floors, scaffolds are not used, and the fall distance exceeds 30 feet. [1710(e)(2)]
4. Connecting beams at the periphery of a building or structure, where the fall distance exceeds 30 feet and the use of approved personal fall protection is impractical. [1710(g)(5)]

SPECIFICATIONS

A. Guardrails

1. Railings are made of selected lumber free from damage or equivalent material. [1620(a)]
2. Top rail 42-45 inches from floor to top of rail. [1620(a)]
3. Midrail installed halfway between the top rail and the floor. [1620(a)]
4. Top rails, handrails, and post are at least 2-inch by 4-inch, and midrails are at least 1-inch by 6-inch. [1620(a)(b), and (c)]
5. Wooden posts and the stair uprights are to be spaced on 8-foot or closer centers. [1620(b), 1626(a)]
6. Railings are to be capable of withstanding a load of 13 pounds per linear foot applied vertically or horizontally at the top rail. [1620(f)]

B. Perimeter Cable

1. A 3/8" cable with a minimum of 13,500 pounds of breaking strength. [1710(e)(3)]
2. The cable is to be at 42 -45 inches from finished floor height. [1710(e)(3)]

C. Toeboard

1. 4 inches (nominal) minimum in vertical height, toeboards are required on all open sides and ends of scaffolds at locations where persons are required to work or pass under. It may be made of any substantial material, either solid or with openings not over 1 inch in greatest dimension. [1621(b)]

D. Covers

1. All covers for floor or roof openings in any work surface are securely fastened and shall be capable to withstand weight greater than a 200—pound person or the weight of workers and/or material on them. [1632(b)]
2. All covers shall have a painted or stenciled sign with at least one inch high legible letters stating: "Opening- Do Not Remove." [1632(b)]

E. Body Belts, Harnesses, Lanyard and Anchorage

1. All personal fall arrest, personal fall restraint and positioning device systems purchased or placed in service after February 1, 1997, shall be labeled as meeting the requirements contained in ANSI A 10.14-1991 or ANSI Z 359.1-1992 for Personal Fall Arrest Systems. [1670(l,m)]
Note: All safety belts, harnesses and lanyards placed or purchased on or before February 1, 1997 shall be labeled with ANSI A 10.14-1975.
2. Any lanyard, safety belt, or dropline subjected to in-service loading, is to be immediately removed from service. [1670(h)]
3. Lifelines and anchorages shall be capable of supporting a minimum dead weight of 5000 pounds. [1670(i)]
4. Lanyards are to be secured at a level not lower than the employee's waist, limiting the fall distance to a maximum of 4 feet nor contact any lower level. [1670(b)(11)(B)]

F. Roof Warning Lines

Roof warning lines are to be capable of 500 pounds tensile strength, installed at 34 to 45 inches above roof, with a visible material hanging at 6 feet intervals. [1730(b)(2)]

G. Safety Nets

1. Safety net shall be approved and extended at least 8 feet horizontally from the perimeter, and positioned at a distance not to exceed 10 feet vertically below. [1671(a)]
2. Sufficient clearance to prevent user's contact with below surfaces.
3. Clearances shall be determined by impact loading test.
4. Safety nets purchased on or after January 1, 1998 shall be labeled as meeting the requirements of American National Standards Institute (ANSI) A10.11-1989, American National Standard for Construction and Demolition Operations - Personnel and Debris Nets. Safety nets purchased before January 1, 1998 shall be labeled as meeting the requirements of ANSI A10.11-1979, Safety Nets Used During Construction, Repair and Demolition Operations, or ANSI A10.11-1989

H. Fall Protection Plan

1. *Applies to all construction operations when it can be shown that the use of conventional fall protection or compliant alternative measures (scaffolds, ladders, verticle mounted work platforms, etc), is impractical or creates a greater hazard. [1671.1(a)]*
2. *Fall protection plan shall be prepared by a qualified person and developed specifically for the jobsite where work is performed. The name of the qualified person must be in the plan. [1671.1(a)(1)]*
3. *A copy of the fall protection plan with approved changes shall be maintained at the job site. [1671.1(a)(3)]*
4. *The implementation of the plan shall be under the supervision of the competent person. [1671.1(a)(4)]*
5. *Document reasons why the use of conventional fall protection systems (guardrails, personal fall arrest systems, or safety nets) are infeasible or why their use would create a greater hazard. [1671.1(a)(5)]*
6. *Plan shall include written discussion of other measures to be taken to reduce or eliminate fall hazard for workers. For example, the employer shall discuss the extent to which scaffolds, ladder, or vehicle mounted work platforms can be used to provide a safer working surface and reduce the fall hazard. [1671.1(a)(6)]*
7. *Plan shall identify each location where conventional fall protection methods cannot be used and these shall be designated "controlled access zones". [1671.1(a)(7)]*
8. *The employer shall implement a safety monitoring system when fully compliant alternative measures. (i.e. scaffolds, ladders, vehicle mounted work platforms, etc.) are not used. [1671.1(a)(8)]*
9. *Plan must provide the name or identification for each employee who is designated to work in controlled zones. [1671.1(a)(9)]*
10. *In the event an employee falls, or a serious accident occurs (near miss), the employer shall investigate the circumstances of the fall and determine if changes are needed (new practices, procedures, or training) and implement them. [1671.1(a)(10)]*

I. Controlled Access Zones and Safety Monitoring Systems

1. *The controlled access zone shall be defined by a control line or by any other means that restricts access. Signs shall be posted to warn unauthorized employees to stay out of the controlled zone. [1671.2(a)(1)]*
2. *The control lines shall extend along the entire length of the unprotected or leading edge. Control lines shall consist of ropes, wires, tapes, or equivalent materials, and supporting stanchions. [1671.2(a)(4)(6)]*
3. *Safety monitoring systems. [1671.2(b)(1)]*

When required the employer shall designate a competent person to monitor the safety of other employees and the employer shall ensure that the safety monitor complies with the following requirements: [1671.2(b)(1)]

 - *Shall be competent to recognize fall hazards;*
 - *Shall warn the employee when it appears employee is unaware of fall hazard or is acting in an unsafe manner.*
 - *Shall be within visual distance of employee or in communication with employee being monitored.*
 - *Shall be close enough to communicate orally with the employee, and not have other responsibilities which could take the monitor's attention from the monitoring function.*
 - (1) *Only the employee covered by a fall protection plan shall be allowed in an area where an employee is being protected by a safety monitoring system. [1671.2(b)(2)]*
 - (2) *Each employee working in a controlled access zone shall be directed to comply promptly with fall hazard warnings from safety monitors. [1671.2(b)(3)]*

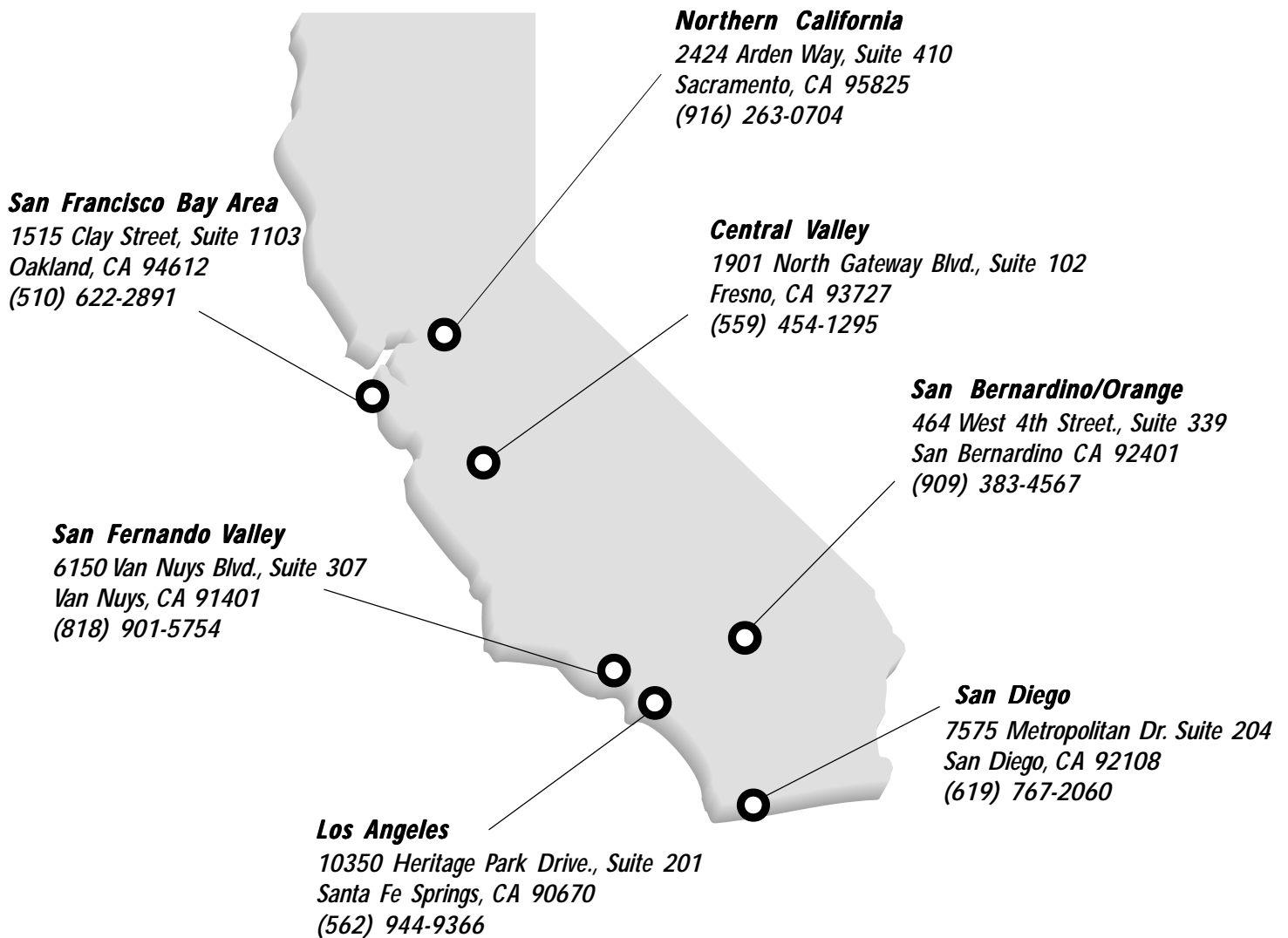

Your call will in no way trigger an inspection by Cal/OSHA Enforcement

- Voluntary Protection Program
San Francisco, CA 94142
(415) 703-5272

- Education Unit
Sacramento, CA 95825
(916) 574-2528

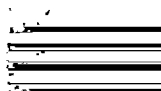

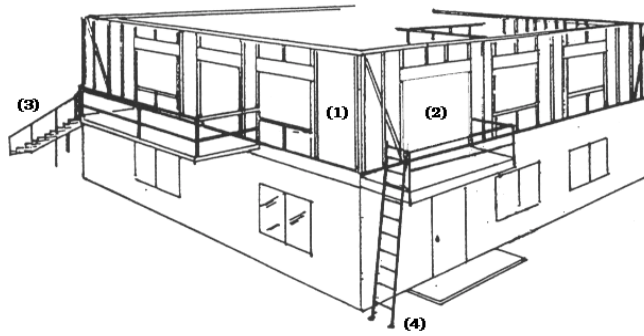

RESIDENTIAL CONSTRUCTION – FRAMING WALLS AND MULTI ACTIVITIES

ID	Title 8	SUBJECT	DESCRIPTION
(1)	1632 J 1632 b	Exterior wall (typical 16" stud spacing)	Doorways & windows (openings less than 3 ft. above work surface- <i>ie.</i> low window sill may require top rail) must be guarded. Floor openings 12 inches or more and any depth shall be covered (secured and marked) or guarded by railing.
(2)	1621	Railings and Toeboards (toeboards when workers are exposed underneath).	All open sides of elevated platforms, balconies, and landings 7 ½ ft. or more high must have guardrails. Where floor deck is to be enclosed by exterior walls, guardrails must be provided until the walls are raised and braced off.
(3)	1629	Permanent or temporary stairways - 2 or more story construction	Provide stairway at least 24 inches wide, with handrails, treads and landings (landings to be railed on open sides).
(4)	3276 1675 1676	Ladders-safe access Job-made ladders	Ladders must extend 36 inches above landing and be secured from displacement-face ladder using both hands. Use only properly constructed ladder.
(5)	1670 a	Approved personal fall arrest/restraint	For fall distance more than 7 ½ ft. from open perimeter, unprotected sides and edges of structure.
(6)	1509-1511, 1513, 1514	Code of safe work practices, training & instructions, & house-keeping	Adopt, post and follow work practices to include instruction upon hiring, use of required safety equipment, reporting unsafe work practices and keeping work areas clear of construction debris.

Control Measures in Preventing Falls

1. *Prior to the presence of its employees, employers shall make a thorough survey of the worksite to determine the predictable hazards and extent of safeguard necessary to conduct work in a safe manner.*
2. *Determine if any work (even a small portion) can be performed **at ground level** or if a lifting device can be used to lift assembled portions (e.g, sections of roofing) into place, eliminating or reducing the number of workers exposed to falling.*
3. *Consider the use of aerial lifts or elevated platforms to provide better working surfaces, rather than walking top plates, joists, or beams.*
4. *Erect guardrails and ensure that all components are secured in place to protect workers from falls off edges.*
5. *Place covers over openings (mark and secure covers) as soon as the openings are created.*
6. *Use personal fall arrest systems (body harness) when required.*

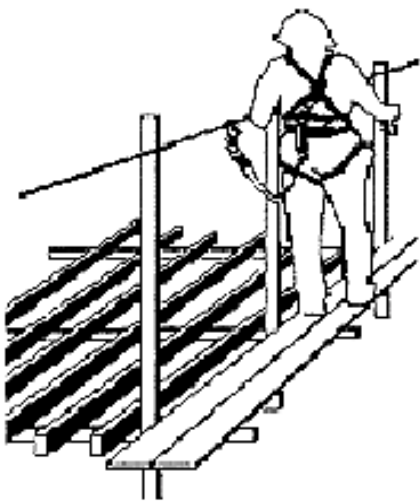

Worker attached to a horizontal lifeline with a shock-absorbing lanyard

This "blueprint" is not meant to be either a substitute for - or a legal interpretation of - the occupational safety and health regulations. It is intended as a quick field reference to a selection of Cal/OSHA regulations applicable to a range of construction operations.

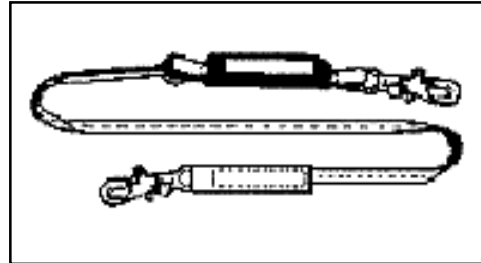

Shock-absorbing lanyard

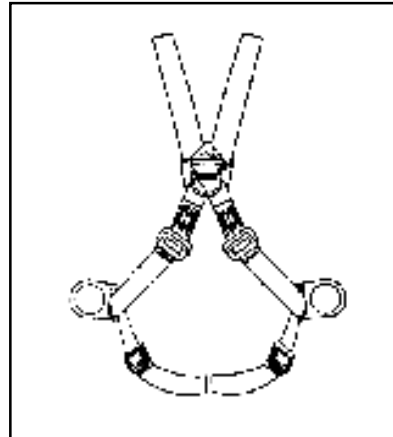

Fall arrest with work positioning

Safe work practices to provide protection from fall -

1. *Where conventional fall protection or compliant alternative measures can be shown to be impractical, designate workers as safety monitors to observe employees and to alert them of hazards and unsafe work practices that could cause a trip or fall.*
2. *All workers shall be given frequent accident prevention instructions (e.g., safe use of fall protection equipment). New workers must be instructed upon arrival at the worksite.*
3. *Foreman, supervisors and leadpersons must insist on employees observing and obeying all rules, regulations, and orders as is necessary for the safe conduct of the work.*

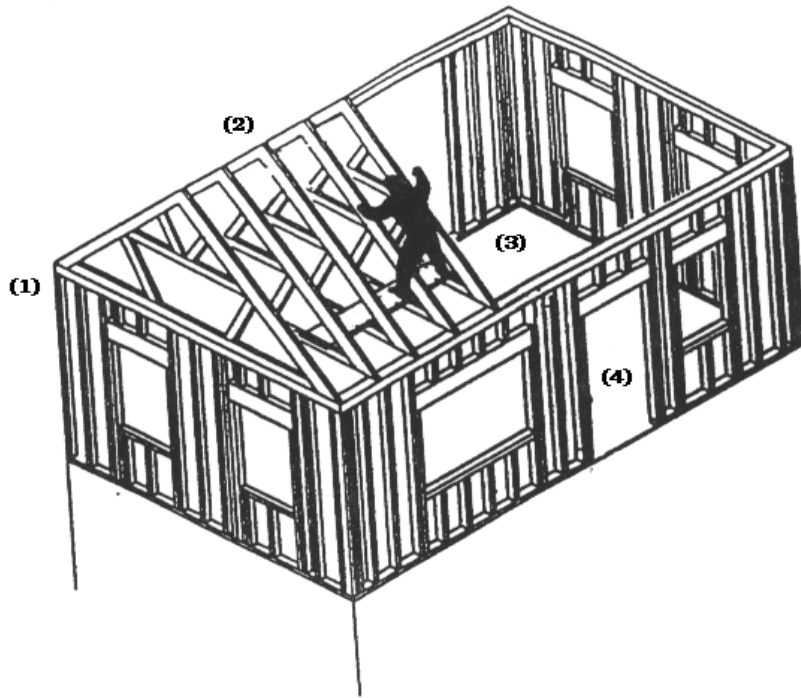

RESIDENTIAL CONSTRUCTION – RAFTER/TRUSS/JOIST INSTALLATION

ID	Title 8	SUBJECT	DESCRIPTION
(1)	1669 a	Work on top plate or beams of 4" nominal width or greater	Fall protection system required when fall distance exceeds 15 feet. Exposure usually exists when working off/on outer walls (two story and higher construction).
(2)	1710 a-1,2	Trusses and Joists installation	Must be braced laterally and progressively to prevent overturning. Joist hangers and trusses must be properly placed/braced and nailed.
(3)	1637 a	Trusses and Joists installation	Provide scaffolds when no solid construction exists (*exception: on joists or the bottom chord of trusses on 2 ft. centers when a 12 inch wide plank is provided).
(4)	1621(a) 1670(a)	Guardrails approved personal fall arrest/restraint	Shall be worn for work other than 1669 and 1637 for fall distance more than 7 ½ ft.
(5)	1509 b, 1510 & 1513	Safe work practices and housekeeping	Adopt, post and follow safe work practices to include proper erection procedures and removal of construction debris (prevent tripping hazards).

Control Measures in Preventing Falls

1. *Prior to the presence of its employees, employers shall make a thorough survey of the worksite to determine the predictable hazards and extent of safeguard necessary to conduct work in a safe manner.*
2. *Determine if any work (even a small portion) can be performed **at ground level** or if a lifting device can be used to lift assembled portions (e.g, sections of roofing) into place, eliminating or reducing the number of workers exposed to falling.*
3. *Consider the use of aerial lifts or elevated platforms to provide better working surfaces, rather than walking top plates, joists, or beams.*
4. *Erect guardrails and ensure that all components are secured in place to protect workers from falls off edges.*
5. *Place covers over openings (mark and secure covers) as soon as the openings are created.*
6. *Use personal fall arrest systems (body harness) when required.*

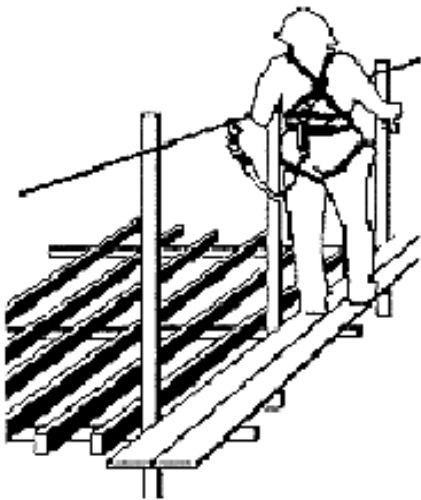

Worker attached to a horizontal lifeline with a shock-absorbing lanyard

This "blueprint" is not meant to be either a substitute for - or a legal interpretation of - the occupational safety and health regulations. It is intended as a quick field reference to a selection of Cal/OSHA regulations applicable to a range of construction operations.

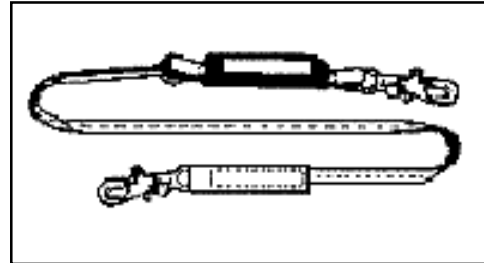

Shock-absorbing lanyard

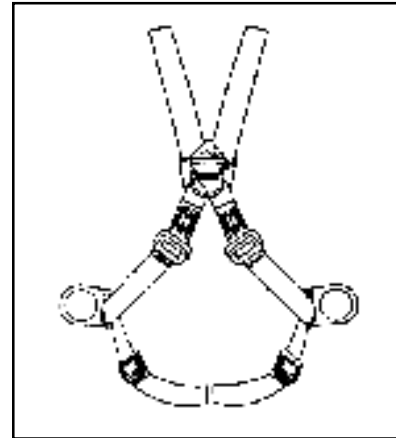

Fall arrest with work positioning

Safe work practices to provide protection from fall -

1. *Where conventional fall protection or compliant alternative measures can be shown to be impractical, designate workers as safety monitors to observe employees and to alert them of hazards and unsafe work practices that could cause a trip or fall.*
2. *All workers shall be given frequent accident prevention instructions (e.g., safe use of fall protection equipment). New workers must be instructed upon arrival at the worksite.*
3. *Foreman, supervisors and leadpersons must insist on employees observing and obeying all rules, regulations, and orders as is necessary for the safe conduct of the work.*

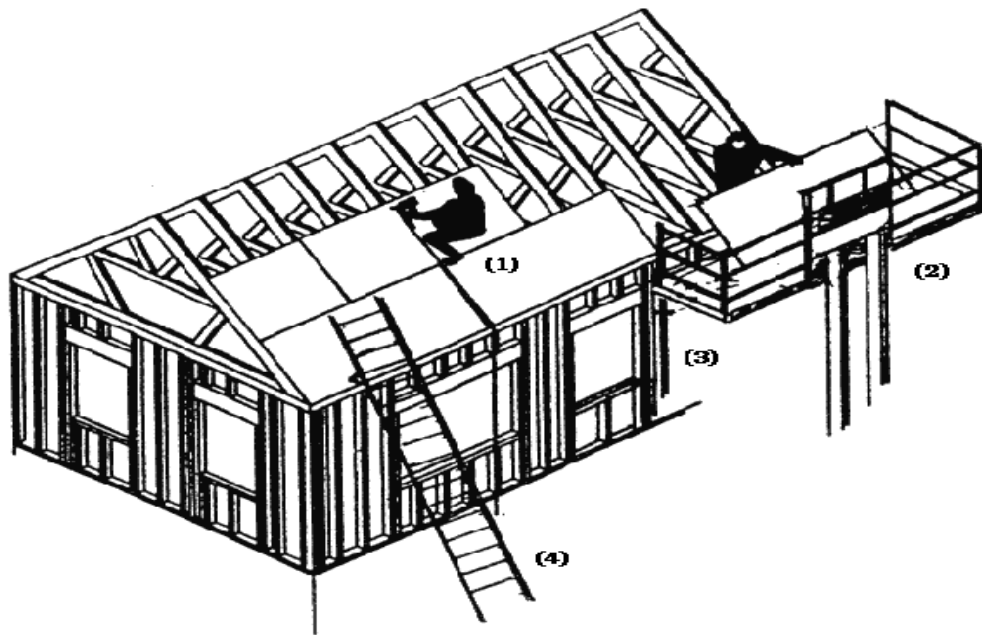

RESIDENTIAL CONSTRUCTION – DECKING/SHEATHING

ID	Title 8	SUBJECT	DESCRIPTION
(1)	1621 a 1670 a	Sheathing floor decks & framing walls	Fall protection system required when fall distance exceeds 7 ½ ft.
(2)	3664, 3657 (GISO)	Lift Trucks used for elevating material and or employees	Operating rules must be posted and enforced. Platform shall have guardrails, toeboards, backguards, and will be secured to forks or mast. Operator must be at the controls when employees are elevated.
(3)	1621 a 1670 a	Sheathing roofs	Fall protection system required when fall distance exceeds 7 ½ ft. Personal fall arrest anchors must sustain a 5000-lb load.
(4)	1675 1676	Ladders-safe access Job-made ladders	Ladders must extend 36 inches above landing and be secured from displacement-face ladder using both hands. Use only properly constructed ladder.
(5)	1509 b, 1510 & 1513	Code of safe work practices, training & instructions, & housekeeping	Adopt, post and follow work practices to include: slippery surfaces, secure sheathing, and walking joist. Train and instruct upon hiring. Remove construction debris to prevent tripping hazards and cover all openings (mark and secure covers).

Control Measures in Preventing Falls

- 1. Prior to the presence of its employees, employers shall make a thorough survey of the worksite to determine the predictable hazards and extent of safeguard necessary to conduct work in a safe manner.*
- 2. Determine if any work (even a small portion) can be performed **at ground level** or if a lifting device can be used to lift assembled portions (e.g. sections of roofing) into place, eliminating or reducing the number of workers exposed to falling.*
- 3. Consider the use of aerial lifts or elevated platforms to provide better working surfaces, rather than walking top plates, joists, or beams.*
- 4. Erect guardrails and ensure that all components are secured in place to protect workers from falls off edges.*
- 5. Place covers over openings (mark and secure covers) as soon as the openings are created.*
- 6. Use personal fall arrest systems (body harness) when required.*

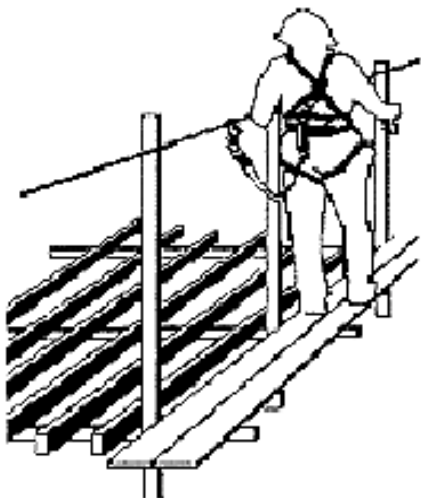

Worker attached to a horizontal lifeline with a shock-absorbing lanyard

This "blueprint" is not meant to be either a substitute for - or a legal interpretation of - the occupational safety and health regulations. It is intended as a quick field reference to a selection of Cal/OSHA regulations applicable to a range of construction operations.

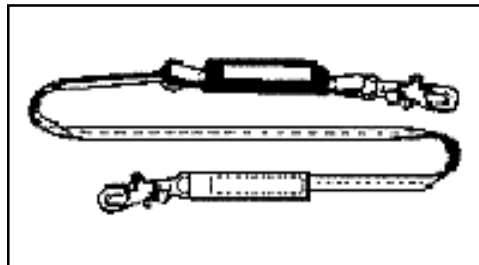

Shock-absorbing lanyard

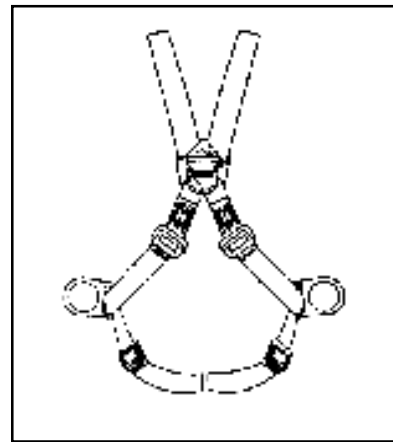

Fall arrest with work positioning

Safe work practices to provide protection from fall -

- 1. Where conventional fall protection or compliant alternative measures can be shown to be impractical, designate workers as safety monitors to observe employees and to alert them of hazards and unsafe work practices that could cause a trip or fall.*
- 2. All workers shall be given frequent accident prevention instructions (e.g., safe use of fall protection equipment). New workers must be instructed upon arrival at the worksite.*
- 3. Foreman, supervisors and leadpersons must insist on employees observing and obeying all rules, regulations, and orders as is necessary for the safe conduct of the work.*

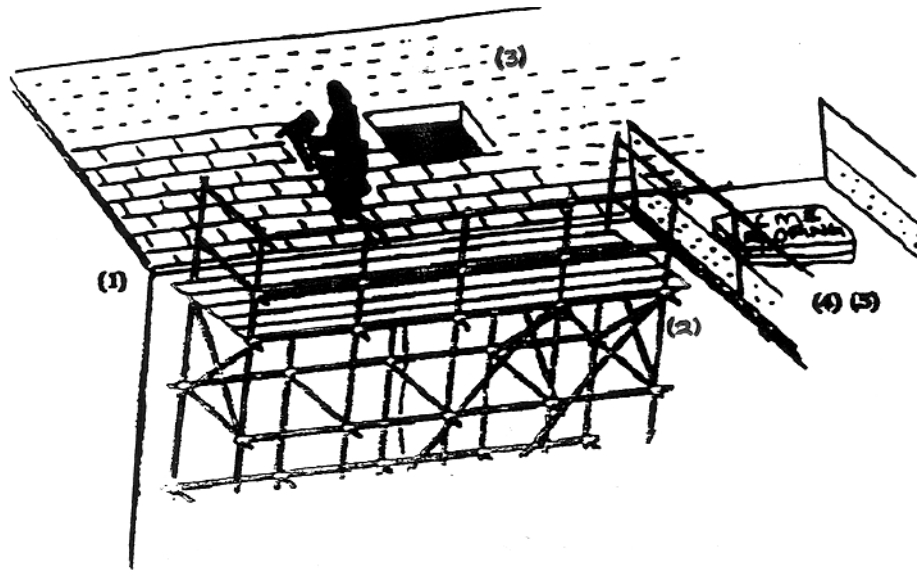

RESIDENTIAL CONSTRUCTION – ROOFING
(Weatherproofing, NOT sheathing)

<i>ID</i>	<i>Title 8</i>	<i>SUBJECT</i>	<i>DESCRIPTION</i>
(1)	1730 b	<i>Protection from falls from roofs</i>	<i>For roofing as defined in 1723, fall protection must be provided when fall height is more than 20 ft. from eaves (sheathing and framing is carpentry not roofing) 1669/ 1670).</i>
(2)	1724 c	<i>Catch platforms</i>	<i>Scaffolds if used as catch platforms, must extend at least 2 ft. from eaves, and be provided with standard railings and toeboards.</i>
(3)	1632 b	<i>Roof openings</i>	<i>Openings 12 inches or more and any depth (such as skylights) shall be covered (secured and marked) or guarded by railing.</i>
(4)	1724 g	<i>High lift material trucks</i>	<i>Material loading/work platforms (7 ½ ft. or more high) shall have guardrails on open sides.</i>
(5)	1724 h	<i>Roof ramps and runways-loading</i>	<i>Min.40 inches in width and guardrailed if more than 20 ft. high.</i>
(6)	1730 a, 1509-1511, 1513, 1514	<i>Training/instructing workers and code of work practices & housekeeping</i>	<i>Adopt, post and follow work practices to include instruction upon hiring, use of required safety equipment, reporting unsafe work practices and keeping work areas clear of construction debris.</i>

Control Measures in Preventing Falls

1. *Prior to the presence of its employees, employers shall make a thorough survey of the worksite to determine the predictable hazards and extent of safeguard necessary to conduct work in a safe manner.*
2. *Determine if any work (even a small portion) can be performed **at ground level** or if a lifting device can be used to lift assembled portions (e.g, sections of roofing) into place, eliminating or reducing the number of workers exposed to falling.*
3. *Consider the use of aerial lifts or elevated platforms to provide better working surfaces, rather than walking top plates, joists, or beams.*
4. *Erect guardrails and ensure that all components are secured in place to protect workers from falls off edges.*
5. *Place covers over openings (mark and secure covers) as soon as the openings are created.*
6. *Use personal fall arrest systems (body harness) when required.*

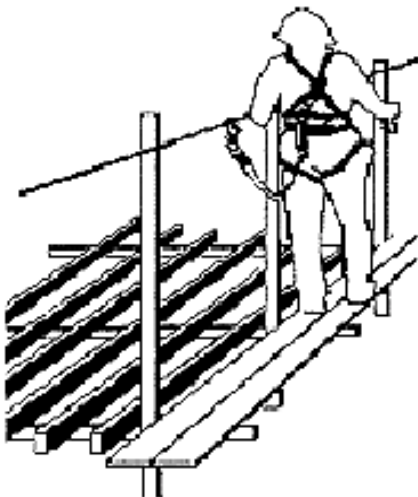

Worker attached to a horizontal lifeline with a shock-absorbing lanyard

This "blueprint" is not meant to be either a substitute for - or a legal interpretation of - the occupational safety and health regulations. It is intended as a quick field reference to a selection of Cal/OSHA regulations applicable to a range of construction operations.

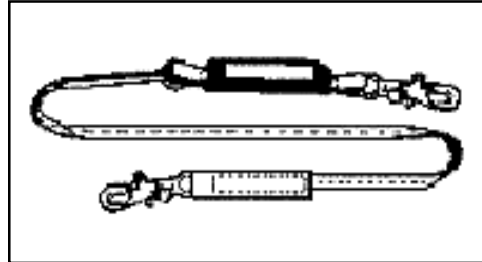

Shock-absorbing lanyard

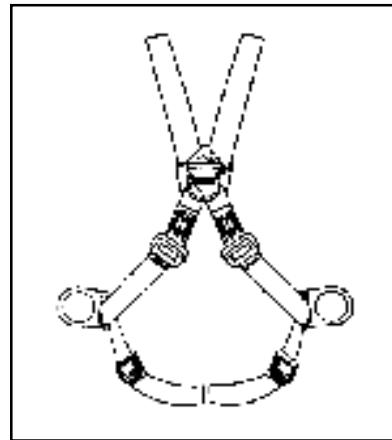

Fall arrest with work positioning

Safe work practices to provide protection from fall -

1. *Where conventional fall protection or compliant alternative measures can be shown to be impractical, designate workers as safety monitors to observe employees and to alert them of hazards and unsafe work practices that could cause a trip or fall.*
2. *All workers shall be given frequent accident prevention instructions (e.g., safe use of fall protection equipment). New workers must be instructed upon arrival at the worksite.*
3. *Foreman, supervisors and leadpersons must insist on employees observing and obeying all rules, regulations, and orders as is necessary for the safe conduct of the work.*

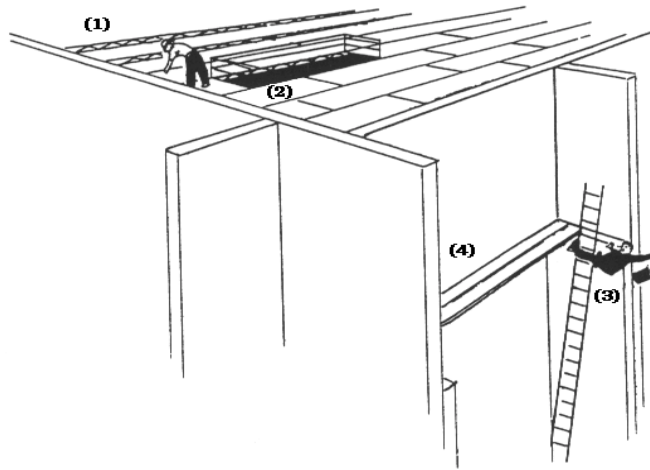

COMMERCIAL CONSTRUCTION – DECKING
(Warehouse, gyms, business blds., stores, similar structures)

<i>ID</i>	<i>Title 8</i>	<i>SUBJECT</i>	<i>DESCRIPTION</i>
(1)	1716.1, 1635	<i>Working on leading edge-to include floors</i>	<i>Fall protection must be used when exposed to fall greater than 15 ft.</i>
(2)	1632 b, *1635 a, 6, 8	<i>Roof openings, missing panels, unsecured covers, proper panel installation *Floor openings.</i>	<i>Openings 12 inches or more and any depth (such as skylight openings) shall be covered (secured and marked) or guarded by railing. Panels shall be laid tightly together and secured (to safely sustain loads).</i>
(3)	1675 1676	<i>Ladders-safe access Job-made ladders</i>	<i>Ladders must extend 36 inches above landing and be secured from displacement-face ladder using both hands. Use only properly constructed ladder.</i>
(4)	1621(a) 1670	<i>Guardrails, approved personal fall arrest/restraint</i>	<i>For fall distance more than 7 ½ ft.</i>
(5)	1509-1511, 1513, 1514	<i>Code of safe work practices, training & instructions, & housekeeping</i>	<i>Adopt, post and follow work practices to include; slippery surfaces, secure sheathing, and walking joist. Train and instruct upon hiring. Remove construction debris to prevent tripping hazards and cover all openings (mark and secure covers).</i>

Control Measures in Preventing Falls

1. *Prior to the presence of its employees, employers shall make a thorough survey of the worksite to determine the predictable hazards and extent of safeguard necessary to conduct work in a safe manner.*
2. *Determine if any work (even a small portion) can be performed at ground level or if a lifting device can be used to lift assembled portions (e.g, sections of roofing) into place, eliminating or reducing the number of workers exposed to falling.*
3. *Consider the use of aerial lifts or elevated platforms to provide better working surfaces, rather than walking top plates, joists, or beams.*
4. *Erect guardrails and ensure that all components are secured in place to protect workers from falls off edges.*
5. *Place covers over openings (mark and secure covers) as soon as the openings are created.*
6. *Use personal fall arrest systems (body harness) when required.*

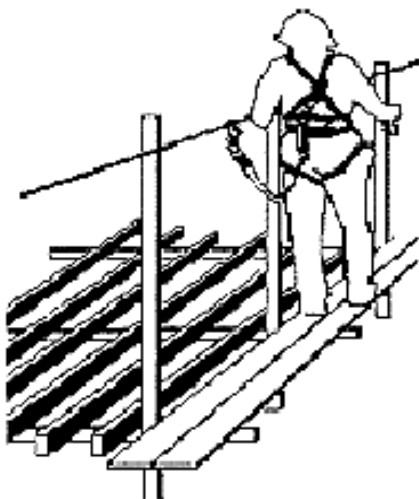

Worker attached to a horizontal lifeline with a shock-absorbing lanyard

This "blueprint" is not meant to be either a substitute for - or a legal interpretation of - the occupational safety and health regulations. It is intended as a quick field reference to a selection of Cal/OSHA regulations applicable to a range of construction operations.

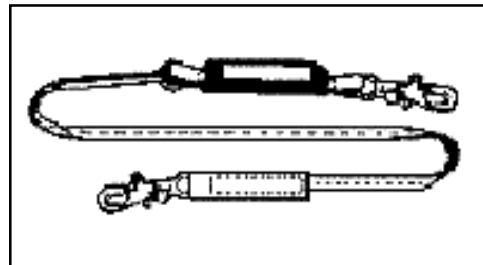

Shock-absorbing lanyard

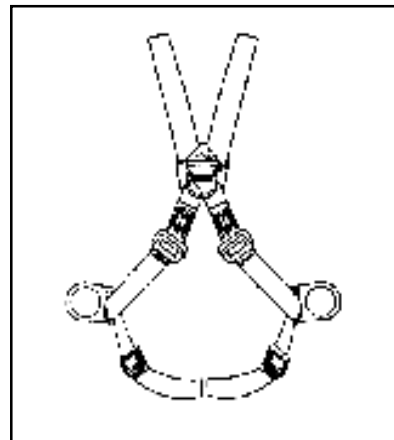

Fall arrest with work positioning

Safe work practices to provide protection from fall -

1. *Where conventional fall protection or compliant alternative measures can be shown to be impractical, designate workers as safety monitors to observe employees and to alert them of hazards and unsafe work practices that could cause a trip or fall.*
2. *All workers shall be given frequent accident prevention instructions (e.g., safe use of fall protection equipment). New workers must be instructed upon arrival at the worksite.*
3. *Foreman, supervisors and leadpersons must insist on employees observing and obeying all rules, regulations, and orders as is necessary for the safe conduct of the work.*

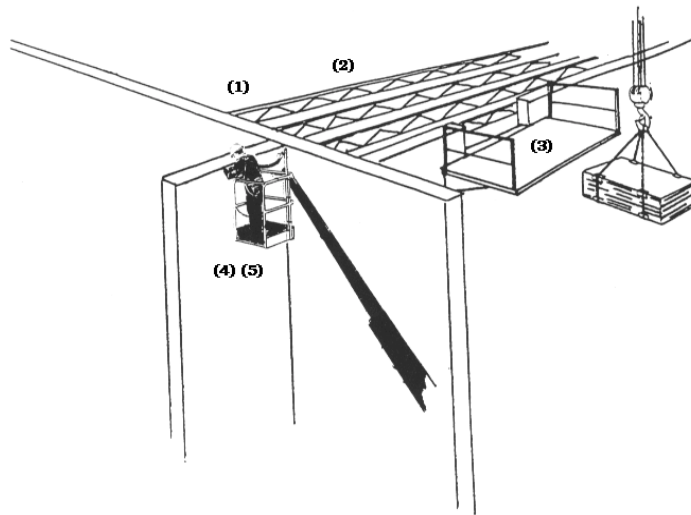

**COMMERCIAL CONSTRUCTION – PRE-CAST, WOOD, METAL
(Warehouse, gyms, business blds., stores, similar structures)**

<i>ID</i>	<i>Title 8</i>	<i>SUBJECT</i>	<i>DESCRIPTION</i>
(1)	1710 a, b	<i>Bracing and erection of trusses and beams</i>	<i>Trusses and beams must be braced laterally and progressively (prevent movement). Erection plan required for beams over 25 feet.</i>
(2)	1716.1, 1669, 1635	<i>Working on trusses, joists, beams. Reference structural steel (1710) for metal/steel installation.</i>	<i>Fall protection must be used when exposed to fall greater than 15 ft.</i>
(3)	1621 1632	<i>Material platforms, wall openings.</i>	<i>Open sides of platforms must be protected by guardrails (removable if needed) for fall distance more than 7 ½ ft.</i>
(4)	3648 (GISO)	<i>Approved fall restraint systems required in aerial devices (man basket)</i>	<i>When working from an elevated aerial device, worker must be secured to the boom, basket or tub by proper safety device (i.e. fall arrest or restraint device).</i>
(5)	1716.1(d)	<i>Elevating employees with lift truck.</i>	<i>Operating rules must be posted and enforced. Platform shall have guardrails, toeboards, backguards, and will be secured to forks or mast. Operator must be at the controls when employees are elevated.</i>
(6)	1509-1511 1513, 1514	<i>Code of safe work practices, training & instruction to use safety equipment</i>	<i>Adopt, post and follow work practices to include instructing upon hiring, use of required safety equipment, reporting unsafe work practices and removing construction debris.</i>

Control Measures in Preventing Falls

1. *Prior to the presence of its employees, employers shall make a thorough survey of the worksite to determine the predictable hazards and extent of safeguard necessary to conduct work in a safe manner.*
2. *Determine if any work (even a small portion) can be performed **at ground level** or if a lifting device can be used to lift assembled portions (e.g, sections of roofing) into place, eliminating or reducing the number of workers exposed to falling.*
3. *Consider the use of aerial lifts or elevated platforms to provide better working surfaces, rather than walking top plates, joists, or beams.*
4. *Erect guardrails and ensure that all components are secured in place to protect workers from falls off edges.*
5. *Place covers over openings (mark and secure covers) as soon as the openings are created.*
6. *Use personal fall arrest systems (body harness) when required.*

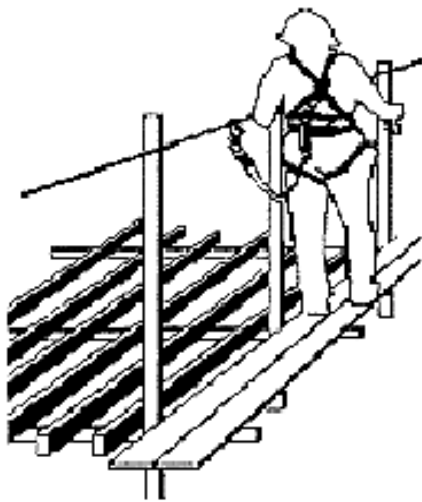

Worker attached to a horizontal lifeline with a shock-absorbing lanyard

This "blueprint" is not meant to be either a substitute for - or a legal interpretation of - the occupational safety and health regulations. It is intended as a quick field reference to a selection of Cal/OSHA regulations applicable to a range of construction operations.

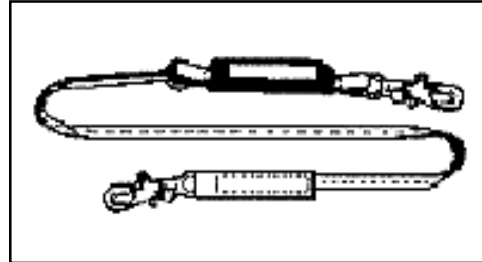

Shock-absorbing lanyard

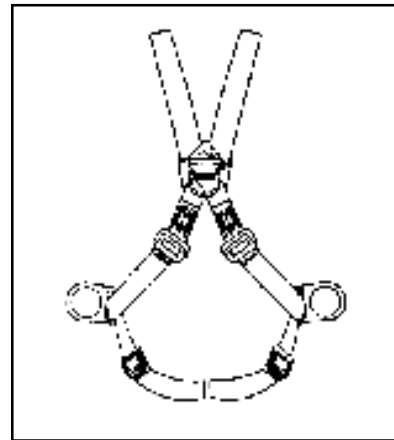

Fall arrest with work positioning

Safe work practices to provide protection from fall -

1. *Where conventional fall protection or compliant alternative measures can be shown to be impractical, designate workers as safety monitors to observe employees and to alert them of hazards and unsafe work practices that could cause a trip or fall.*
2. *All workers shall be given frequent accident prevention instructions (e.g., safe use of fall protection equipment). New workers must be instructed upon arrival at the worksite.*
3. *Foreman, supervisors and leadpersons must insist on employees observing and obeying all rules, regulations, and orders as is necessary for the safe conduct of the work.*

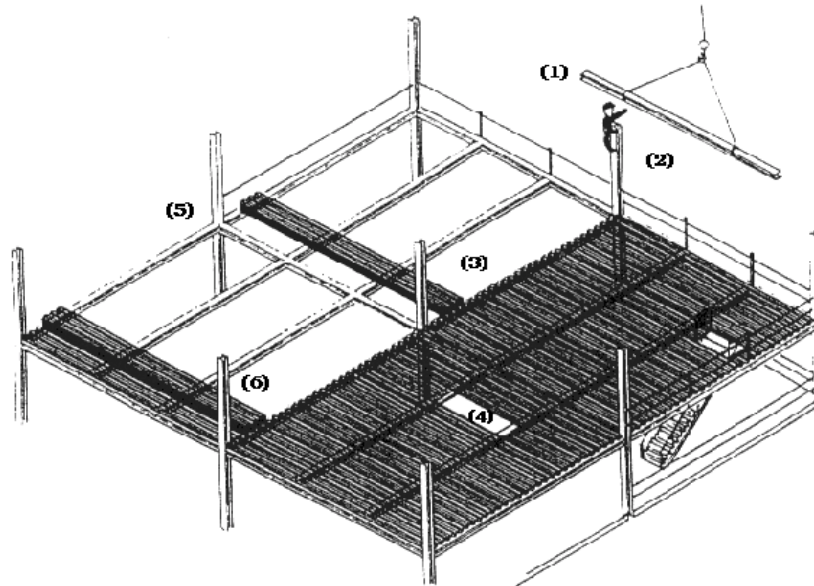

COMMERCIAL CONSTRUCTION – STRUCTURAL STEEL

ID	Title 8	SUBJECT	DESCRIPTION
(1)	1710 c,1-5	Securing web steel	Web structural members must be secured (at least 2 bolts) before releasing load. Web joist must be placed only on secured frame work, no load placed on trusses until bolted with lateral stability.
(2)	1710 g 1,3	Connectin beams	When fall distance is greater than 30 ft.:Workers must be tied off by approved fall arrest equipment, and must coon or walk bottom flange when moving on beams unless tied-off to catenary lines.
(3)	1710 g 2 1669 1635 b	Work other than connecting, includes deck installation and temporary flooring	Fall protection must be used when exposed to falls greater than 15 ft.
(4)	1632 1635 b, 1633	Roof openings, missing panels/covers, access/elevator openings	Openings 12 inches or more and any depth (gaps, missing panels..) shall be covered (secured -marked) or guarded by railing. Panels shall be laid tightly together and secured to safely sustain loads.
(5)	1621	Open sides/ends of work areas-all levels	Guardrail protection may use wire rope (3/8 inch or greater diameter) for fall distance greater than 7 ½ ft.
(6)	1710 a,b	Erection guide for beams over 25 ft.	Erection plan prepared by registered engineer must be available. All beams and supports must be properly braced to foundation.
(7)	1509-1511 1513, 1514	Code of safe work practices, training & instruction to use safety equipment	Adopt, post and follow work practices to include instructing upon hiring, use of required safety equipment, reporting unsafe work practices and removing construction debris.

Control Measures in Preventing Falls

1. Prior to the presence of its employees, employers shall make a thorough survey of the worksite to determine the predictable hazards and extent of safeguard necessary to conduct work in a safe manner.
2. Determine if any work (even a small portion) can be performed **at ground level** or if a lifting device can be used to lift assembled portions (e.g, sections of roofing) into place, eliminating or reducing the number of workers exposed to falling.
3. Consider the use of aerial lifts or elevated platforms to provide better working surfaces, rather than walking top plates, joists, or beams.
4. Erect guardrails and ensure that all components are secured in place to protect workers from falls off edges.
5. Place covers over openings (mark and secure covers) as soon as the openings are created.
6. Use personal fall arrest systems (body harness) when required.

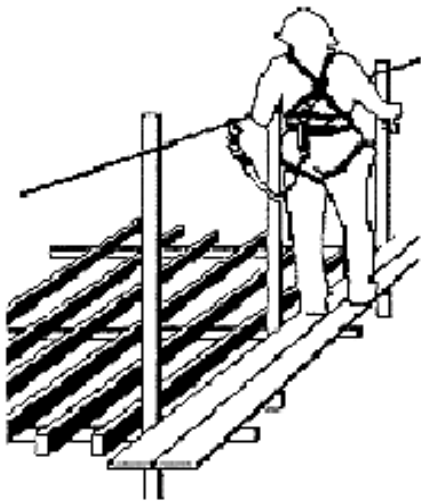

Worker attached to a horizontal lifeline with a shock-absorbing lanyard

This "blueprint" is not meant to be either a substitute for - or a legal interpretation of - the occupational safety and health regulations. It is intended as a quick field reference to a selection of Cal/OSHA regulations applicable to a range of construction operations.

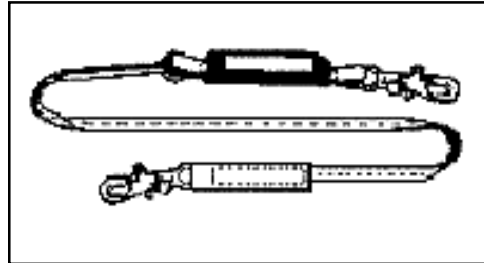

Shock-absorbing lanyard

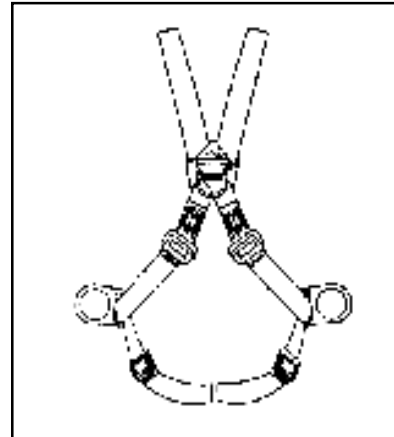

Fall arrest with work positioning

Safe work practices to provide protection from fall -

1. Where conventional fall protection or compliant alternative measures can be shown to be impractical, designate workers as safety monitors to observe employees and to alert them of hazards and unsafe work practices that could cause a trip or fall.
2. All workers shall be given frequent accident prevention instructions (e.g., safe use of fall protection equipment). New workers must be instructed upon arrival at the worksite.
3. Foreman, supervisors and leadpersons must insist on employees observing and obeying all rules, regulations, and orders as is necessary for the safe conduct of the work.

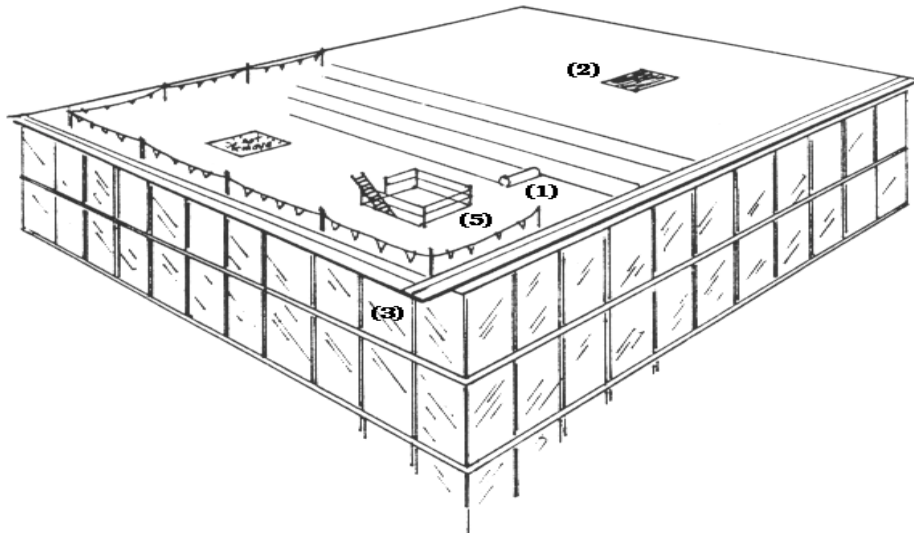

COMMERCIAL CONSTRUCTION – ROOFING

ID	CCR-Title 8	SUBJECT	DESCRIPTION
(1)	1730 b	Protection from falls from roofs – all roofing to include removal * Walking backwards when pulling equipment	Fall protection must be provided when fall height is more than 20 ft. for roofers doing roofing as defined in 1723 (decking/sheathing is not roofing). * When pulling felt laying equipt.- fall protection is required regardless of height.
(2)	1632 b	Roof openings – skylights, access areas, vents etc.	Openings 12 inches or more and any depth shall be covered (secured and marked) and/or guarded by railing.
(3)	1730 b, 1-10	Warning lines and headers	Warning lines (5 ft. of roof edge, 34-45 inches high, 6 ft. intervals) shall be properly placed to prevent falls over roof edge. Headers shall be placed 5 ft. from edge (10 ft. when walking backwards) to warn workers of fall danger.
(4)	1724 g	High lift material trucks	Material loading/work platforms (7 ½ ft. or more high) shall have guardrails/toeboards on open sides.
(5)	1730 b, 6, 7	Material/storage and access areas	Close supervision by qualified person, workers restricted to marked areas (warning lines marking these).
(6)	1730 a, 1509-1511 1513, 1514	Training/instructing workers, code of work practices & housekeeping.	Adopt, post and follow work practices to include instructing upon hiring, use of required safety equipment, reporting unsafe work practices and removing construction debris.

Control Measures in Preventing Falls

1. *Prior to the presence of its employees, employers shall make a thorough survey of the worksite to determine the predictable hazards and extent of safeguard necessary to conduct work in a safe manner.*
2. *Determine if any work (even a small portion) can be performed **at ground level** or if a lifting device can be used to lift assembled portions (e.g, sections of roofing) into place, eliminating or reducing the number of workers exposed to falling.*
3. *Consider the use of aerial lifts or elevated platforms to provide better working surfaces, rather than walking top plates, joists, or beams.*
4. *Erect guardrails and ensure that all components are secured in place to protect workers from falls off edges.*
5. *Place covers over openings (mark and secure covers) as soon as the openings are created.*
6. *Use personal fall arrest systems (body harness) when required.*

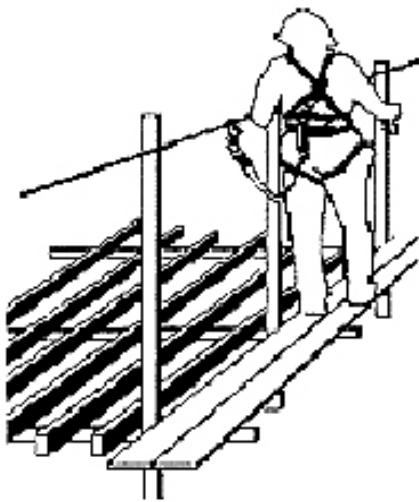

Worker attached to a horizontal lifeline with a shock-absorbing lanyard

This "blueprint" is not meant to be either a substitute for - or a legal interpretation of - the occupational safety and health regulations. It is intended as a quick field reference to a selection of Cal/OSHA regulations applicable to a range of construction operations.

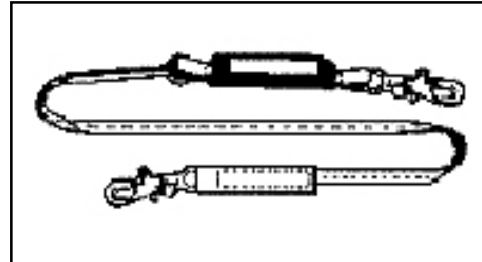

Shock-absorbing lanyard

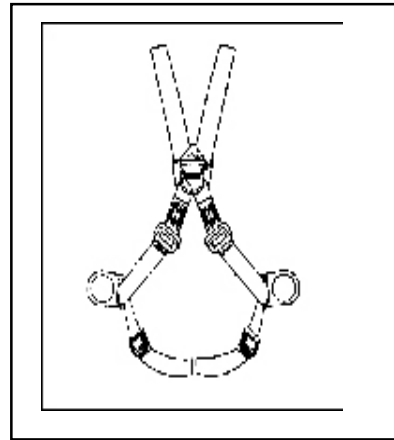

Fall arrest with work positioning

Safe work practices to provide protection from fall -

1. *Where conventional fall protection or compliant alternative measures can be shown to be impractical, designate workers as safety monitors to observe employees and to alert them of hazards and unsafe work practices that could cause a trip or fall.*
2. *All workers shall be given frequent accident prevention instructions (e.g., safe use of fall protection equipment). New workers must be instructed upon arrival at the worksite.*
3. *Foreman, supervisors and leadpersons must insist on employees observing and obeying all rules, regulations, and orders as is necessary for the safe conduct of the work.*